



KIESELMANN
FLUID PROCESS GROUP

Translation of the original

Operating instruction

Multiturn actuators Type: 4x00

pneumatic - mechanical
for butterfly valves and ball valves



KIESELMANN GmbH

Paul-Kieselmann-Str. 4-10
75438 Knittlingen

 +49(0) 7043 371-0 •  +49(0) 7043 371-125
www.kieselmann.de • info@kieselmann.de

Copyright: © KIESELMANN FLUID PROCESS GROUP

Table of contents

| | | |
|----------|---|-----------|
| 1 | General informations | 4 |
| 1.1 | Informations for your safety | 4 |
| 1.2 | Marking of security instructions | 4 |
| 1.3 | General designated use | 4 |
| 1.4 | Personnel | 4 |
| 1.5 | Modifications, spare parts, accessories | 5 |
| 1.6 | General instructions | 5 |
| 2 | Safety instructions..... | 6 |
| 2.1 | Intended use | 6 |
| 2.2 | General notes..... | 6 |
| 2.3 | General safety instructions..... | 6 |
| 3 | Delivery, transport and storage | 7 |
| 3.1 | Delivery..... | 7 |
| 3.2 | Transport..... | 7 |
| 3.3 | Storage..... | 7 |
| 4 | Function and operation | 8 |
| 4.1 | Description of function..... | 8 |
| 4.2 | Control system and position indication | 9 |
| 5 | Commissioning, service and maintenance | 10 |
| 5.1 | Commissioning..... | 10 |
| 5.1.1 | Installation instructions..... | 10 |
| 5.1.2 | General welding guidelines | 10 |
| 5.1.3 | ATEX - Guidelines | 10 |
| 5.2 | Service..... | 11 |
| 5.3 | Cleaning | 11 |
| 6 | Technical data | 12 |
| 6.1 | Multiturn actuators..... | 12 |
| 6.2 | Torques | 13 |
| 7 | Dimensions..... | 15 |
| 8 | Wearing parts | 16 |
| 8.1 | Spare parts list..... | 16 |
| 9 | Appendix | 17 |
| 9.1 | Declaration of incorporation..... | 17 |

1 General informations

1.1 Informations for your safety

We are pleased that you have decided for a high-class KIESELMANN GmbH product. With correct application and adequate maintenance, our products provide long time and reliable operation.





Before installation and initiation, please carefully read this instruction manual and the security advices contained in it. This guarantees reliable and safe operation of this product and your plant respectively. Please note that an incorrect application of the process components may lead to great material damages and personal injury.

In case of damages caused by non observance of this instruction manual, incorrect initiation, handling or external interference, guarantee and warranty will lapse!

Our products are produced, mounted and tested with high diligence. However, if there is still a reason for complaint, we will naturally try to give you entire satisfaction within the scope of our warranty. We will be at your disposal also after expiration of the warranty. In addition, you will also find all necessary instructions and spare part data for maintenance in this instruction manual. If you don't want to carry out the maintenance by yourself, our KIESELMANN GmbH - service team will naturally be at your disposal.

1.2 Marking of security instructions

Hints are available in the chapter "safety instructions" or directly before the respective operation instruction. The hints are highlighted with a danger symbol and a signal word. Texts beside these symbols have to be read and adhered to by all means. Please continue with the text and with the handling at the valve only afterwards.

| Symbol | Signal word | Meaning |
|---|-------------|---|
|  | DANGER | Imminent danger which will result severe personal injury or death. |
|  | WARNING | Imminent danger which may result severe personal injury or death. |
|  | CAUTION | Dangerous situation which may cause slight personal injury or material damages. |
|  | NOTICE | An harmful situation which may result in damages of the product itself or of adjacent vicinity. |
|  | INFORMATION | Marks application hints and other information which is particularly useful. |

1.3 General designated use

The fitting is designed exclusively for the purposes described below. Using the fitting for purposes other than those mentioned is considered contrary to its designated use. KIESELMANN GmbH cannot be held liable for any damage resulting from such use. The risk of such misuse lies entirely with the user. The prerequisite for the reliable and safe operation of the fitting is proper transportation and storage as well as competent installation and assembly. Operating the fitting within the limits of its designated use also involves observing the operating, inspection and maintenance instructions.

1.4 Personnel

Personnel entrusted with the operation and maintenance of the tank safety system must have the suitable qualification to carry out their tasks. They must be informed about possible dangers and must understand and observe the safety instructions given in the relevant manual. Only allow qualified personnel to make electrical connections.

1.5 Modifications, spare parts, accessories

Unauthorized modifications, additions or conversions which affect the safety of the fitting are not permitted. Safety devices must not be bypassed, removed or made inactive. Only use original spare parts and accessories recommended by the manufacturer.

1.6 General instructions

The user is obliged to operate the fitting only when it is in good working order. In addition to the instructions given in the operating manual, please observe the relevant accident prevention regulations, generally accepted safety regulations, regulations effective in the country of installation, working and safety instructions effective in the user's plant.

2 Safety instructions

2.1 Intended use

The pneumatic multiturn actuator can be used for rotary fittings in the beverages and foodstuffs industry, the pharmaceuticals industry and the bio-technology sector, as well as the chemical industry.

2.2 General notes



NOTICE - observe the operating instructions

To avoid danger and damage, the fitting must be used in accordance with the safety instructions and technical data contained in the operating instructions.



NOTICE

All data are in line with the current state of development. Subject to change as a result of technical progress.

2.3 General safety instructions



⚠ WARNING

Risk of injury by pre-stressed pressure spring.

The pneumatic-mechanical actuator is spring-loaded. When disassembling the actuator, components that jump out may cause injuries.

- a) Multiturn actuators are maintenance-free and therefore do not need to be opened!



⚠ WARNING

ATEX - Guidelines

If the valve or the plant is operated in a potentially explosive atmosphere, the valid ATEX directive of the EC and the installation instructions in this operating manual must be observed.



⚠ CAUTION

To avoid air leaking, only use pneumatic connection parts that have an O-ring seal facing the even surface.



⚠ CAUTION

Steps should be taken to ensure that no external forces are exerted on the fitting.

3 Delivery, transport and storage

3.1 Delivery

Immediately after receipt check the delivery for completeness and transport damages.

Remove the packaging from the product.

Retain packaging material, or expose of according to local regulations.

3.2 Transport



CAUTION

Risk of injury and damage to the product

During the transport the generally acknowledged rules of technology, the national accident prevention regulations and company internal work and safety regulations must be observed.

3.3 Storage



NOTICE

Damage to the product due to improper storage!

Observe storage instructions

avoid a prolonged storage



INFORMATION

Recommendation for longer storage

We recommend regularly checking the product and the prevailing storage conditions during long storage times.

- To avoid damage to seals and bearings,
 - products up to DN 125 / OD 5 inch should be stored horizontally for maximum 6 months.
 - products larger than DN 125 / 5 inch, should be stored in the upright position with the actuator on top.
- Don't store any objects on the products.
- Protect the products for wetness, dust and dirt.
- The product should be stored in a dry and well ventilated room at a constant temperature (optimal indoor temperature: 25 C ±5 ; indoor humidity data 70% ±5%).
- Protect seals, bearings and plastic parts for UV light and ozone.

4 Function and operation

4.1 Description of function



air open- spring close (NC)

If compressed air is connected to the air connection port LA1 of the multiturn actuator, its axis will turn 90° clockwise. When bleeding it will reset by spring force.

air open - air close (DA)

If compressed air is connected to the air connection port LA1 or LA2 of the multiturn actuator, its axis will turn 90°.

INFORMATION

- To make sure that the rotary movement really stops at 0°-90° or 90°-0°, make sure to bleed the compressed air port of the rotary drive not being used.
- In order to avoid air leakages, only use an elbow-type screw-in connexion respectively a straight screw-in connexion with sealing by an o-ring to the end face.

The multiturn actuator is used for the following products:

- Butterfly valves (BV) and Leakage butterfly valves (LBV)
- Straight way ball valve (SWBV) and Three-way ball valve (TWBV)

| Actuator | Item number | BV | LBV | SWBV | TWBV |
|--------------------|------------------|-----------|-----------|---------|----------|
| 90 / 75 | | | | | |
| lö-fs (air/spring) | 4200 075 000-022 | DN15/40 | - | DN10/40 | - |
| 90 / 100 | | | | | |
| lö-ls (air/air) | 4100 100 000-022 | DN25/100 | DN50/80 | DN25/80 | DN25/65 |
| lö-fs air/spring) | 4200 100 000-022 | DN25/100 | DN50/80 | DN25/80 | DN25/65 |
| 90 / 125 | | | | | |
| lö-ls (air/air) | 4100 125 000-022 | DN125/150 | DN100/150 | DN100 | DN80/100 |
| lö-fs air/spring) | 4200 125 000-022 | DN125/150 | DN100/150 | DN100 | DN80/100 |

lö = air open; ls = air close; fs = spring close; fō = spring open

4.2 Control system and position indication



Feedback unit -optional-

Optionally, modular valve control head systems can be installed to the actuator for reading and actuating valve positions. The standard version is a closed system with SPS or ASI-bus switch-on electronics, and integrated 3/2-way solenoid valves. For tough operating conditions we recommend employing a high-grade steel cover.



Position indicator with sensor mounting for feedback signal.

The actuator is equipped with a proximity switch mounting (sensor mounting) and a position indication. When inductive proximity initiators M 12x1 are installed, the current "Open" or "Shut" position can be interrogated. By screwing the proximity initiator to the limit position the required switching gap for the signal transmission is established.. When the valve is closed the position indication is oriented vertically to the direction of valve passage. When the valve is open it is oriented parallel to the valve passage.

Standard equipment of the multiturn actuator (A) includes a position indication.



NOTICE

- To prevent leaks, the thread needs to be sealed with a gasket strip when installing the proximity switches.

Proximity switches (Sensors)

The transparent hood (R5) is suitable for commercially available inductive proximity switches (sensors) with thread M12x1. Use proximity switches with non-flush mounting and a nominal operating distance of min. 4.0 mm.

The proximity initiators in different variants can be obtained from KIESELMANN.

Before mounting proximity switches first remove the red plastic caps (R6) from the hood (R5). Then manually screw the proximity switches into the threaded holes of the hood until they arrive at the stop. No adjustment will be required. Counter with a lock nut the switch against the hood (R5) applying little force.

For valve maintenance you may screw the hood (R5) off the drive unit together with the proximity switches.

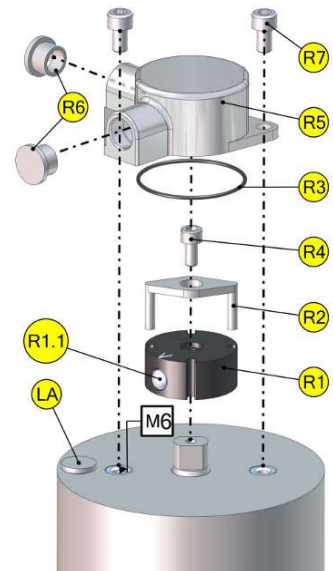

- Position indication with sensor mounting (R)

| | | | |
|------|---------------------|----|------------|
| R1 | dog | R4 | Screw |
| R1.1 | cylinder pin | R5 | Cap |
| R2 | Position indication | R6 | Cap |
| R3 | O-ring | R7 | Screw |
| | | LA | Air supply |

5 Commissioning, service and maintenance

5.1 Commissioning

5.1.1 Installation instructions

Fitting position - Multiturn actuator 90/75

The multiturn actuator should be installed vertically.

Fitting position - Multiturn actuator 90/100 and 90/125

The installation position is without importance. However, there may be valve-specific restrictions.



NOTICE

Risk of shock pressure

You may have to restrict the pressure of the outlet air to avoid shock pressure.



NOTICE

Damage due to impurities

Impurities can cause damage to the seals and seals area.

Clean inside areas prior to assembly.

5.1.2 General welding guidelines

Sealing elements integrated in weld components must generally be removed prior to welding. To prevent damage, welding should be undertaken by certified personnel (EN ISO 9606-1). Use the TIG (Tungsten Inert Gas) welding process.



CAUTION

Damage and injuries due to high temperature supply

To avoid a distortion of the components, all welding parts must be welded to stress-relieved.

Allow all components to cool before assembling.



NOTICE

Damage due to impurities

Impurities can cause damage to the seals and seals area.

Clean inside areas prior to assembly.

5.1.3 ATEX - Guidelines

For valves or plants/installations that are operated in the ATEX area, sufficient bonding (grounding) must be ensured (see valid ATEX Guidelines EG).

5.2 Service

The actuators are maintenance-free and non-removable. The manufacturer guarantees a running time of five years or 50.000 strokes.

Lubricant recommendation

| | | | |
|---|------------------------------|---|--------------------------|
|  | EPDM; HNBR; NBR; FKM; k-flex | - | Klüber Paraliq GTE703* |
| | Silicone | - | Klüber Sintheso pro AA2* |
| | Thread | - | Interflon Food* |
| *) It is only permitted to use approved lubricants, if the respective fitting is used for the production of food or drink. Please observe the relevant safety data sheets of the manufacturers of lubricants. | | | |

5.3 Cleaning

The cleaning of the external surfaces must be performed at regular intervals. The cleaning cycles are to be defined by the user.

6 Technical data

6.1 Multiturn actuators

| | | | |
|---|--|---|------------------|
| Model: | Multiturn actuators, pneumatical enclosed type | | |
| Kind of actuation: | air / air (double action) air / spring (single action) | | |
| Angle of rotation: | 90° (+3°) | | |
| Valve size: | Actuator 90 / 75 Actuator 90 / 100 Actuator 90 / 125 | | |
| Temperature range: | Ambient temperature: +4 to +60°C (air) | | |
| Air supply: | G 1/8 | | |
| Leak rate: | A (DIN EN 12266-1) | | |
| Control air: | <u>Control air pressure:</u> 5,5 - 8,0 bar | <u>Quality of control air:</u> ISO 8573-1 : 2001 quality class 3 | |
| Materials: (in product contact) | Stainless steel: | 1.4301 / AISI304 | |
| | Surfaces: | Ra < 1,5 - 2,5µm e-polished | |
| | Sealing material: | NBR | |
| Air requirement per stroke: (at atmospheric pressure) | Actuator 90 / 75 | air / spring | - 0,20 litre/bar |
| | Actuator 90 / 100 | | - 0,50 litre/bar |
| Actuator 90 / 125 | - 0,70 litre/bar | | |
| | Actuator 90 / 100 | air / air | - 1,30 litre/bar |
| | Actuator 90 / 125 | | - 1,90 litre/bar |

6.2 Torques

Actuator 90/75

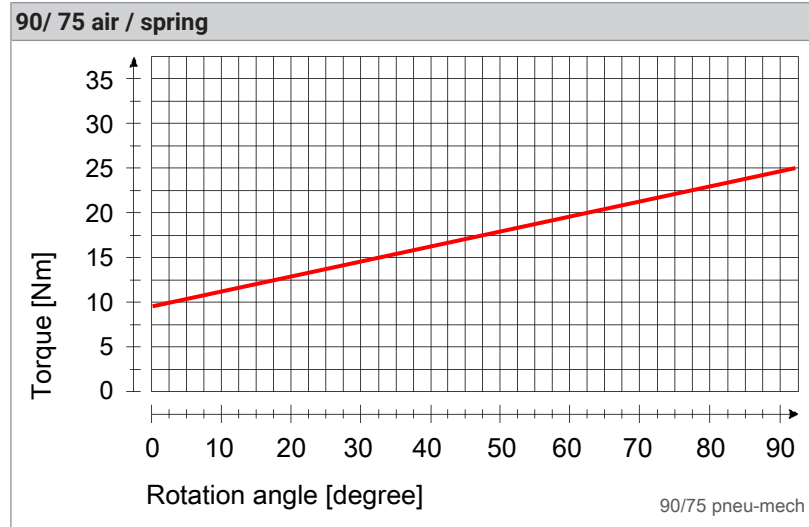

Actuator 90/100

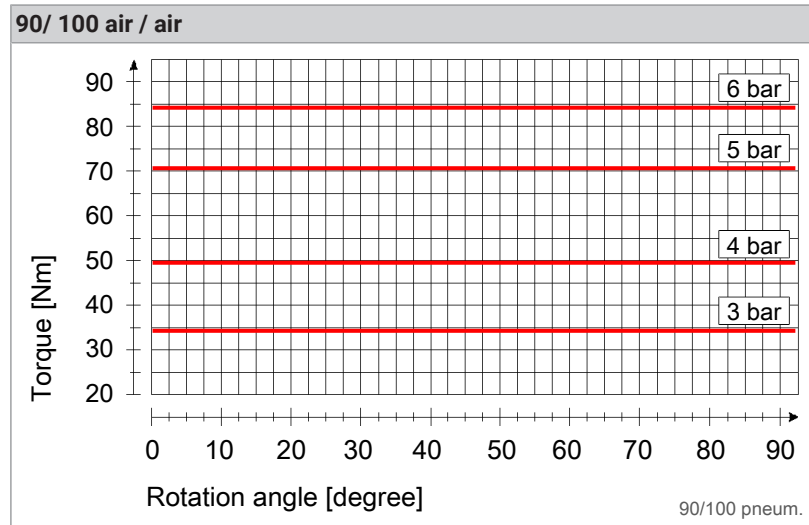
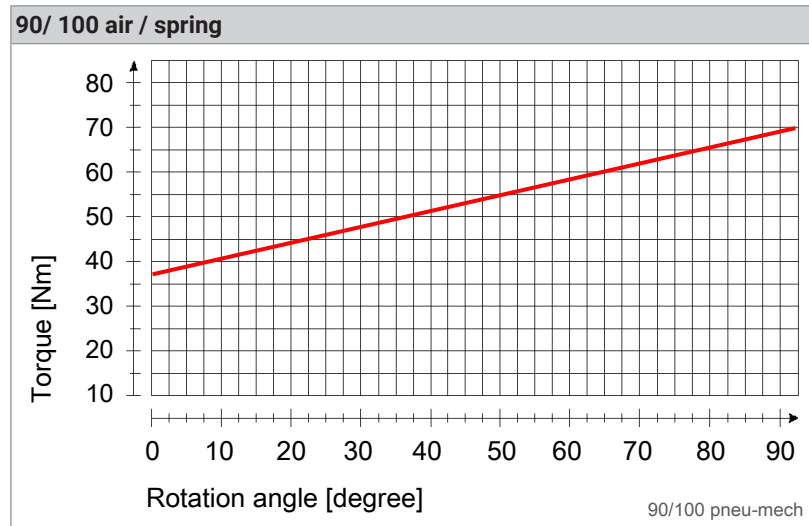

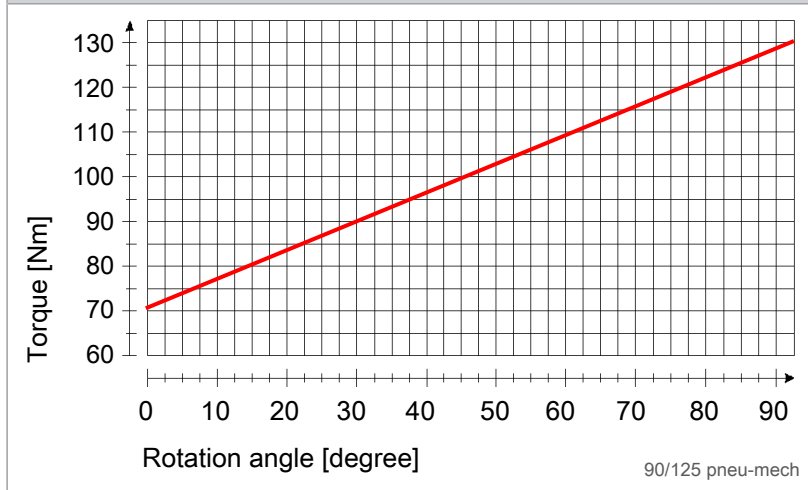
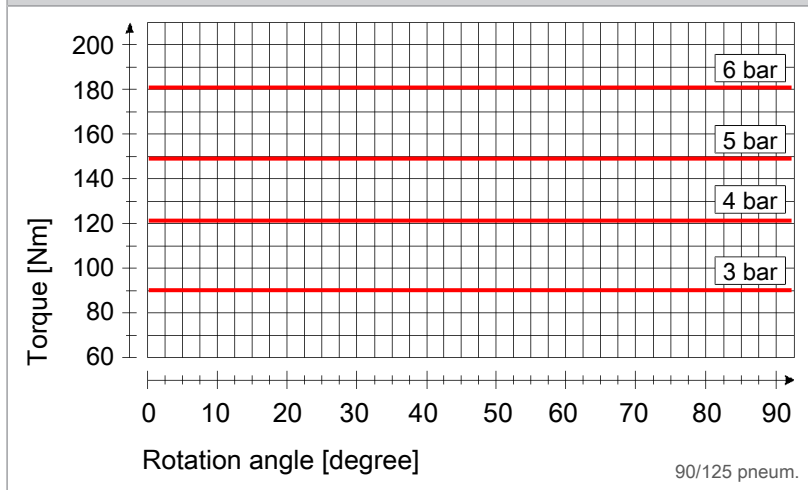
Actuator 90/125**90/ 125 air / spring****90/ 125 air / air**

7 Dimensions

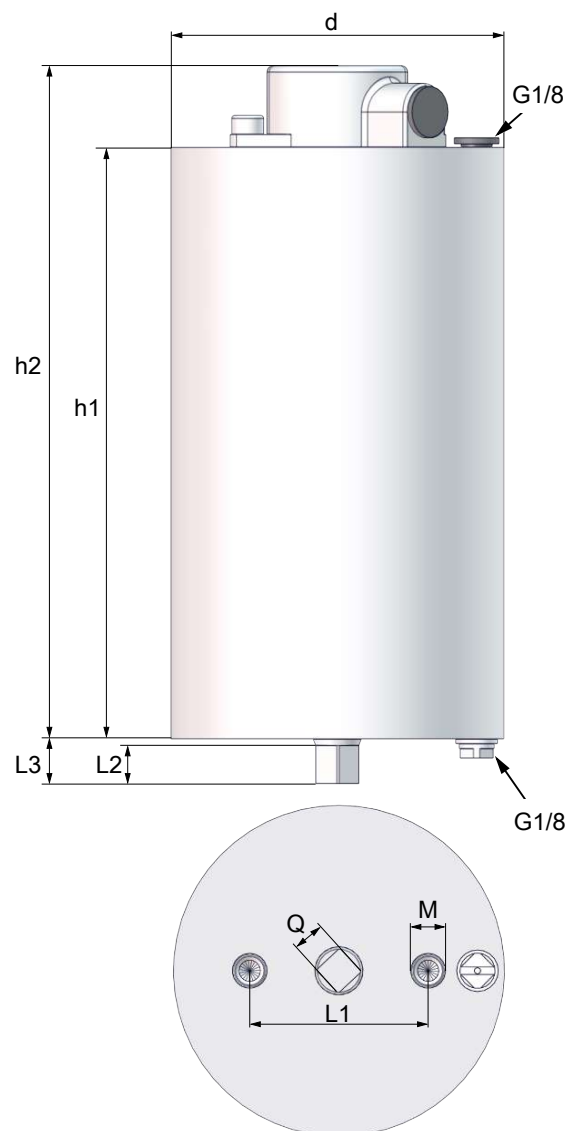

| | Pneum. actuator | | |
|-----------|-----------------|----------|----------|
| | 90 / 75 | 90 / 100 | 90 / 125 |
| d | 76 | 104 | 129 |
| h1 | 142.5 | 186 | 215 |
| h2 | 168 | 211.5 | 240.5 |
| L1 | 56 | 56 | 78 |
| L2 | 12 | 12 | 16 |
| L3 | 14 | 14 | 20 |
| M | M8 | M8 | M8 |
| Q | 10 | 10 | 14 |



8 Wearing parts

8.1 Spare parts list

Actuator

| Pneum. actuator | Type | Item number | Material |
|----------------------------|---|------------------|----------|
| 90 / 75 (Ø 75) | lö-fs (air/spring) | 4200 075 000-022 | AISI 304 |
| | lö-fs (air/spring) with position indication | 4200 075 100-022 | |
| 90 / 100 (Ø 104) | lö-ls (air/air) | 4100 100 000-022 | AISI 304 |
| | lö-ls (air/air) with position indication | 4100 100 100-022 | |
| | lö-fs (air/spring) | 4200 100 000-022 | |
| | lö-fs (air/spring) with position indication | 4200 100 100-022 | |
| 90 / 125 (Ø 125) | lö-ls (air/air) | 4100 125 000-022 | AISI 304 |
| | lö-ls (air/air) with position indication | 4100 125 100-022 | |
| | lö-fs (air/spring) | 4200 125 000-022 | |
| | lö-fs (air/spring) with position indication | 4200 125 100-022 | |

Position indication (R) complete

| Valve type | Item number | Position |
|---|------------------|--|
| <ul style="list-style-type: none"> • Butterfly valves • Leakage - butterfly valves • Straight way ball valve | 4100 100 020-000 | R1.1  |
| <ul style="list-style-type: none"> • Three-way ball valve with L-ball | 4100 100 047-000 | R1.1  |
| <ul style="list-style-type: none"> • Three-way ball valve with T-ball | 4100 100 040-000 | R1.1  |

| Pos. | Designation | Item number | Material | pce. |
|-------------|---------------------|------------------|--------------|------|
| R1 | dog | 4100 100 023-097 | PBT sw | 1 |
| R1:1 | cylinder pin | 8062 081 008-020 | AISI 304 | 1 |
| R2 | Position indication | 4100 100 024-093 | PS rt | 1 |
| R3 | O-ring | 2304 040 015-055 | NBR 70°Sh. | 1 |
| R4 | Allen screw | 8095 005 010-020 | AISI 304 | 1 |
| R5 | Cap | 4100 100 021-094 | MAPS | 1 |
| R6 | Cap | 4301 080 020-095 | GPN 300/F091 | 2 |
| R7 | Allen screw | 8095 006 010-020 | AISI 304 | 2 |

9 Appendix

9.1 Declaration of incorporation



Declaration of incorporation

Translation of the original

Manufacturer / authorised representative:

KIESELMANN GmbH
Paul-Kieselmann-Str. 4-10
75438 Knittlingen
Germany

Authorised representative:
(for compiling technical documents)

Achim Kauselmann
Paul-Kieselmann-Str. 4-10
75438 Knittlingen
Germany

| <u>Product name</u> | <u>Function</u> |
|-------------------------|--|
| pneum. Lift actuators | Stroke movement |
| pneum. Rotary actuators | Rotary movement |
| Ball valves | Media cutoff |
| Butterfly valves | Media cutoff |
| Single seat valves | Media cutoff |
| Flow control valves | Control of liquefied media |
| Throttle valve | Control of liquefied media |
| Overflow valve | Definition of fluid pressure |
| Double seat valve | Media separation |
| Bellow valves | Sampling of liquids |
| Sampling valves | Sampling of liquids |
| Two way valves | Media cutoff |
| Tankdome fitting | Prevention of overpressure and vacuum, Tank cleaning |
| Safety valve | Prevention of overpressure |

The manufacturer hereby states that the above product is considered as an incomplete machine in the sense defined in the Directive 2006/42/EC on Machinery. The above product is exclusively intended to be installed into a machine or an incomplete machine. The said product does not yet conform to all the relevant requirements defined in the Directive on Machinery referred to above for this reason.

The specific technical documents listed in Appendix VII, Part B, have been prepared. The Authorized Agent empowered to compile technical documents may submit the relevant documents if such a request has been properly justified.

Commissioning of an incomplete machine must not only be carried out if it has been determined that the respective machine into which the incomplete machine is to be installed conforms to the regulations set out in the Directive on Machinery referred to above.

The above product conforms to the requirements of the directives and harmonized standards specified below:

- Directive 2014/68/EU
- DIN EN ISO 12100 Safety of machinery

Knittlingen, 21.07.2017

i.V. Uwe Heisswolf
Head of Development